

# 2020 SIDEWALK REPAIRS RIVER OAKS AND FARR ROAD

PROJECT NUMBER: TPI-0100-2020  
JANUARY 2, 2020



**TOWN OF TYRONE**  
881 SENOIA ROAD  
TYRONE, GA 30290  
770-487-4038



VICINITY MAP

## DRAWING INDEX

	TITLE SHEET
C100	DETAILS & SECTION A PLAN VIEW
C101	SECTION B PLAN VIEW
C102	RIVER OAKS PLAN VIEW



NORTH

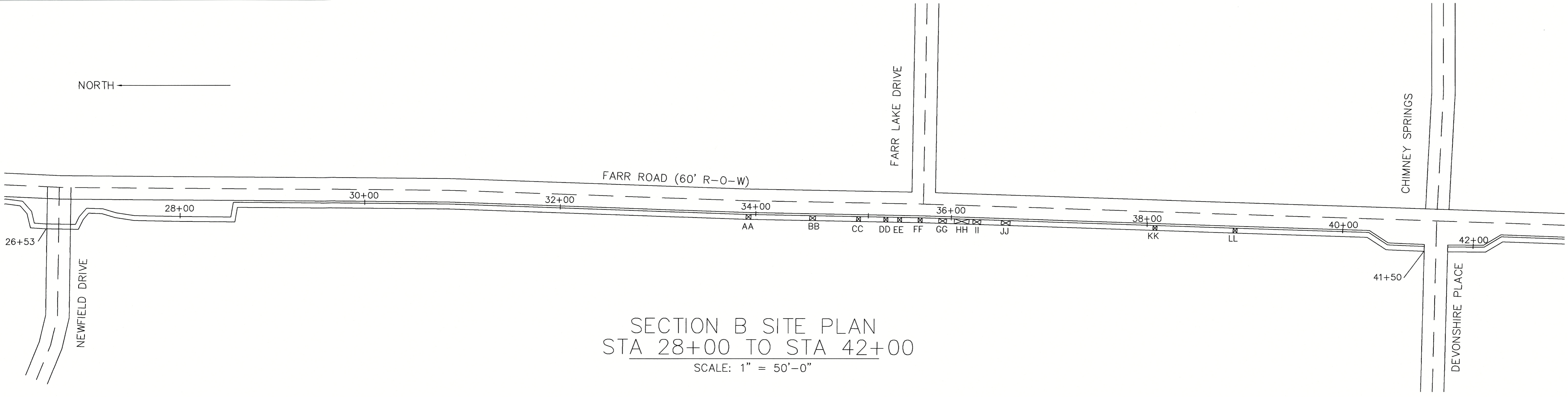

SECTION B SITE PLAN  
 STA 28+00 TO STA 42+00  
 SCALE: 1" = 50'-0"

TABLE OF WORK				
AREA	START STA	END STA	LINEAR FEET	SQUARE FEET
AA	33+90	33+95	5	25
BB	34+55	34+61	6	30
CC	35+03	35+07	4	20
DD	35+31	35+35	4	20
EE	35+45	35+49	4	20
FF	35+66	35+70	4	20
GG	35+87	35+95	8	40
HH	36+03	36+18	15	75
II	36+22	36+30	8	40
JJ	36+51	36+62	9	45
KK	38+06	38+10	4	20
LL	38+88	38+92	4	20
MM	44+96	45+02	6	30
NN	50+61	50+69	8	40
OO	50+75	50+75	*	*
TOTAL			91	455

\* 4" DIAMETER CORE HOLE FILL W/ CONC

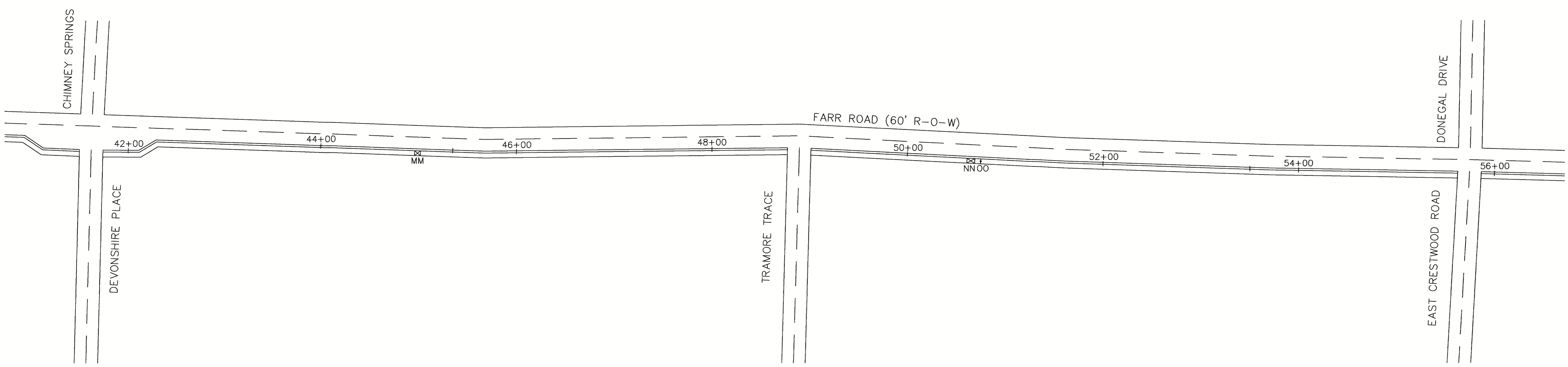

SECTION B SITE PLAN  
 STA 42+00 TO STA 56+00  
 SCALE: 1" = 50'-0"

BEFORE DIGGING IN  
 GEORGIA  
 CALL 811

TOWN OF TYRONE  
 881 SENOIA ROAD  
 TYRONE, GA 30290  
 770-487-4038



Project Name: 2020 SIDEWALK REPAIRS  
 RIVER OAKS AND FARR ROAD  
 Project No.: TPI-0100-2020  
 Location: TOWN OF TYRONE

Site No.	Summary	Date	By

SECTION B  
 PLAN VIEW  
 Sheet Title  
 Scale: AS NOTED  
 Designed by: SAL  
 Drawn by: SAL  
 Sheet No.: C101  
 Date: JAN 2, 2020  
 Filename: 2020 SIDEWALK REPAIRS

BEFORE DIGGING IN  
 GEORGIA  
 CALL 811

TOWN OF TYRONE  
 881 SENOIA ROAD  
 TYRONE, GA 30290  
 770-487-4038

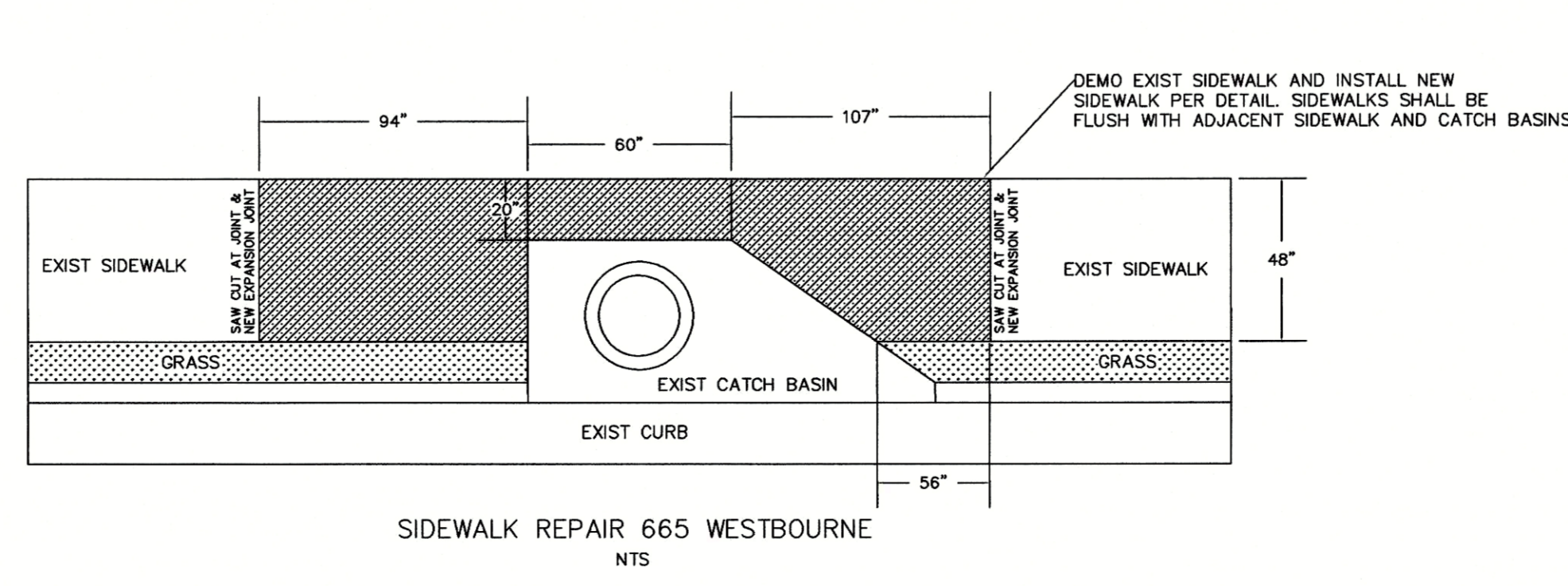
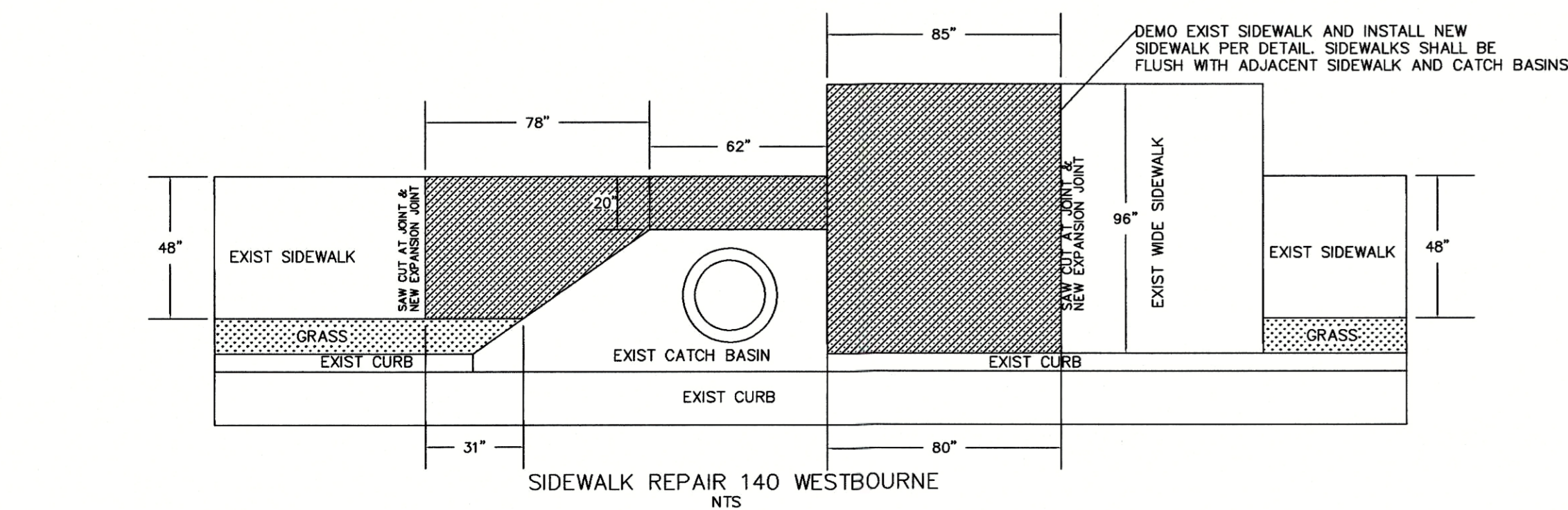
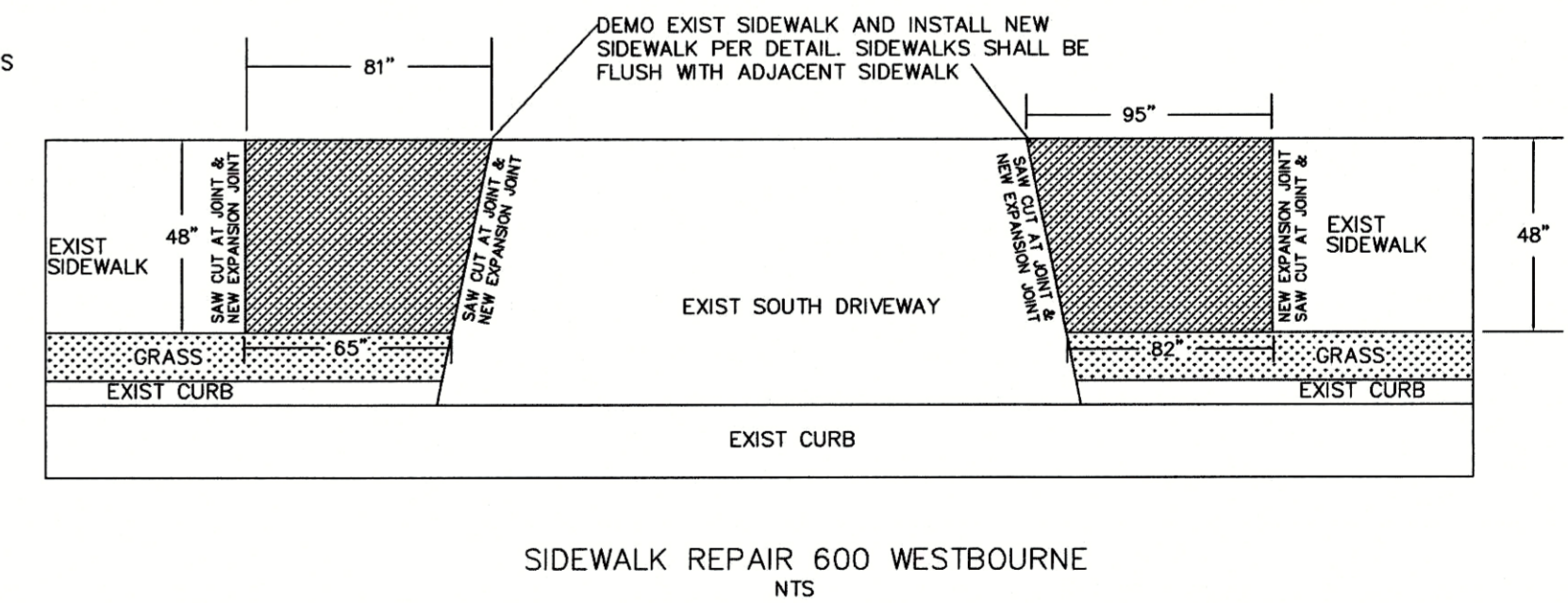
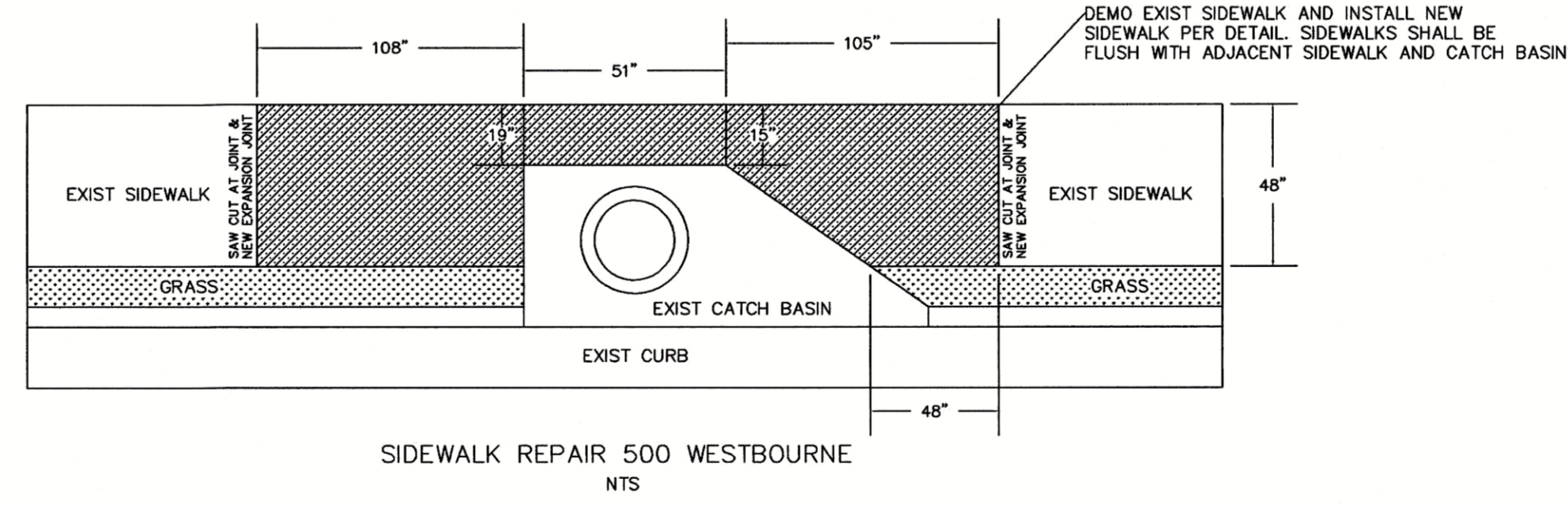
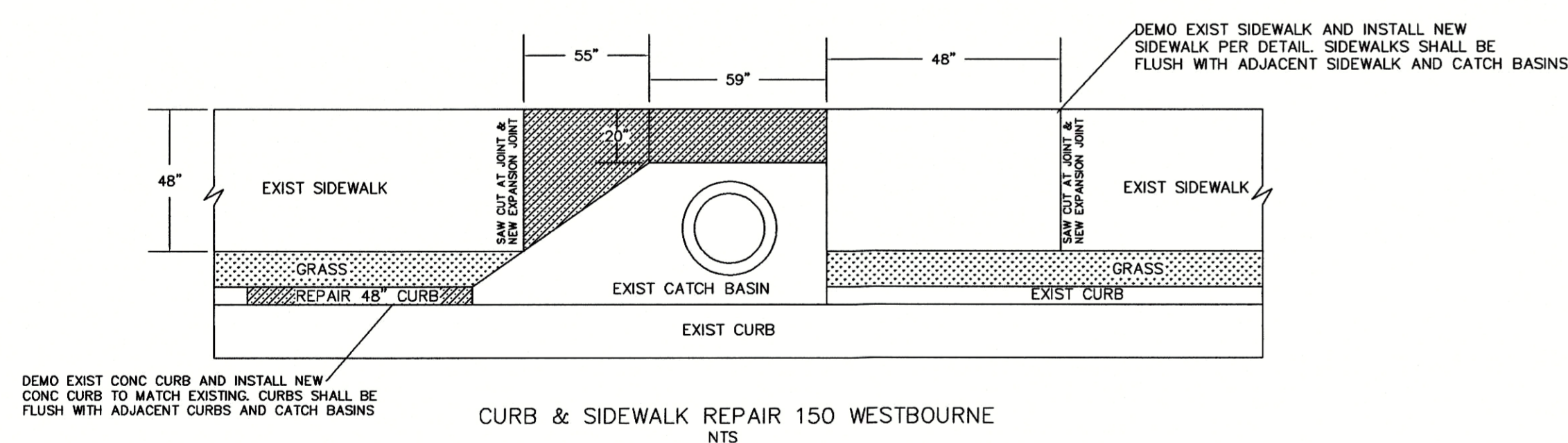
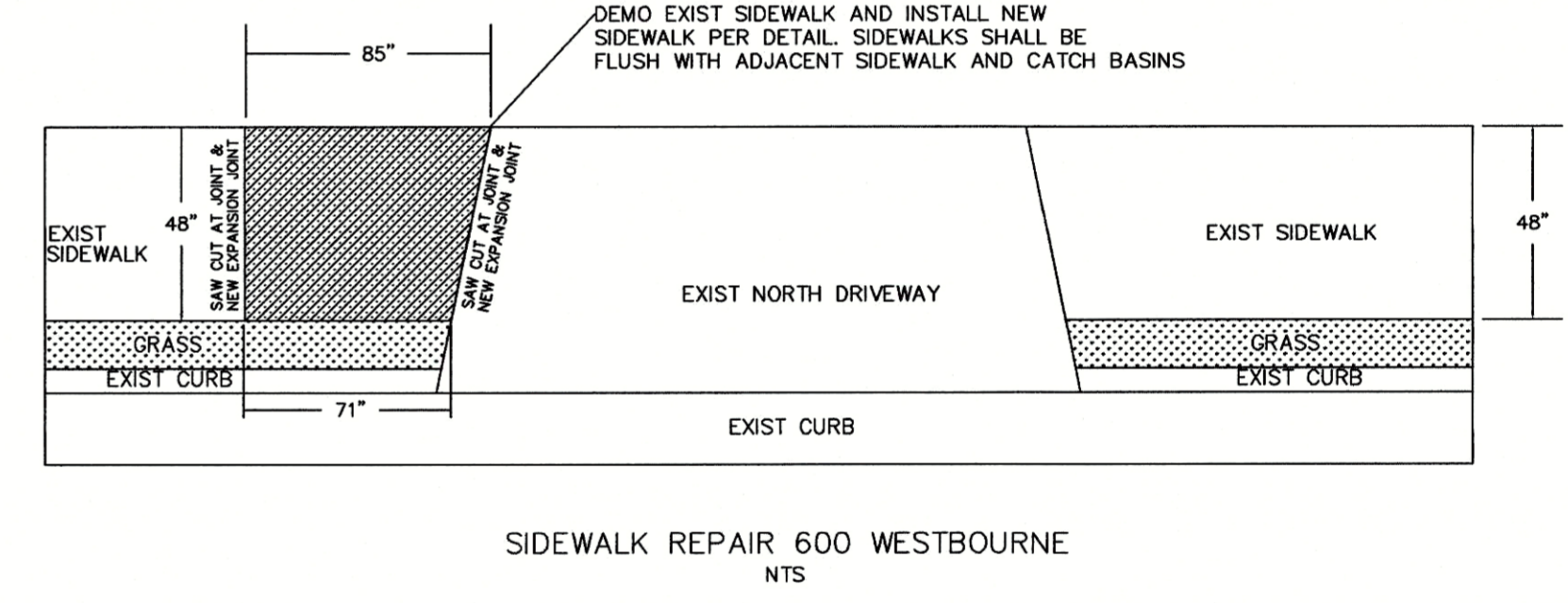
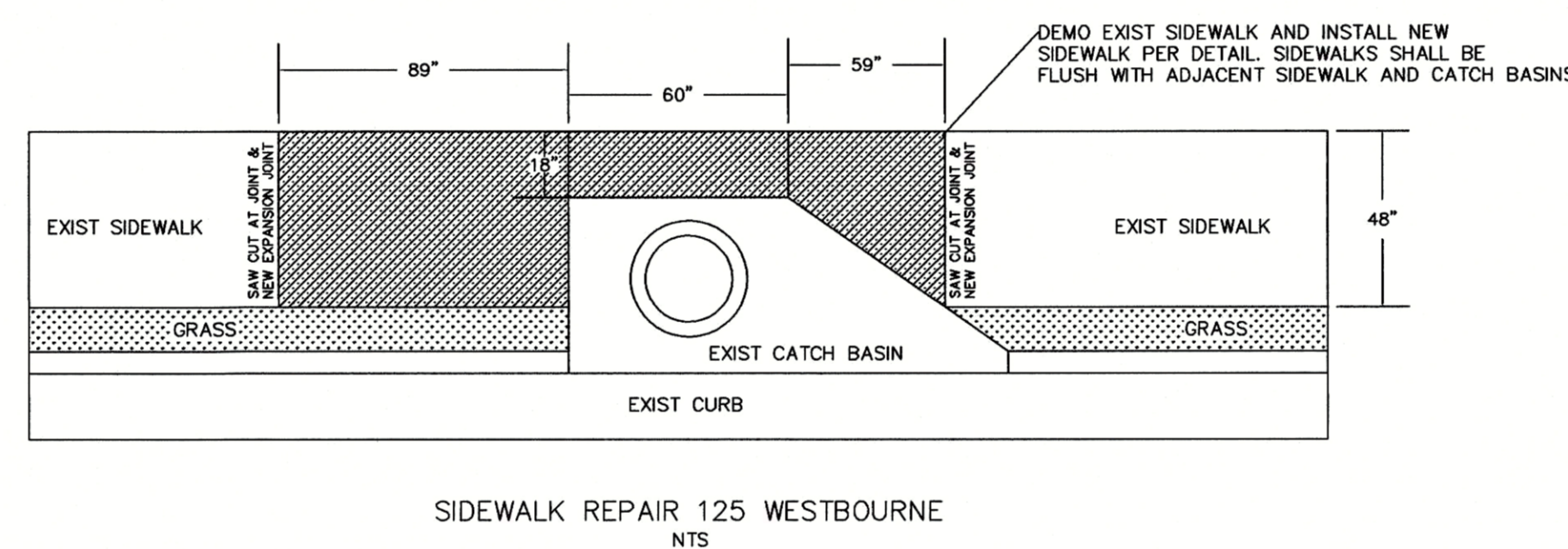
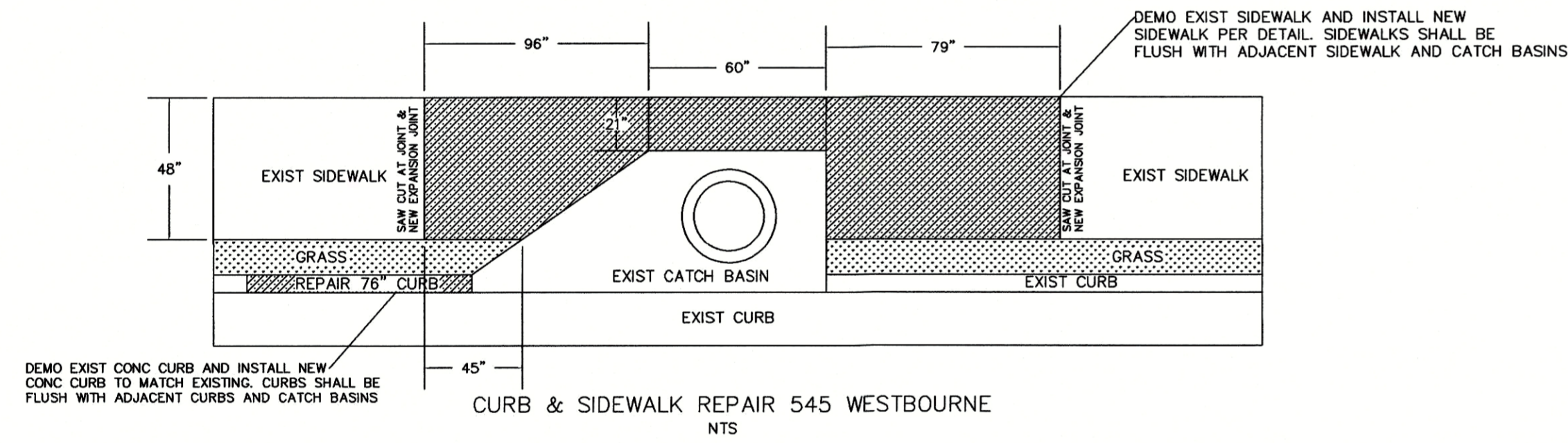
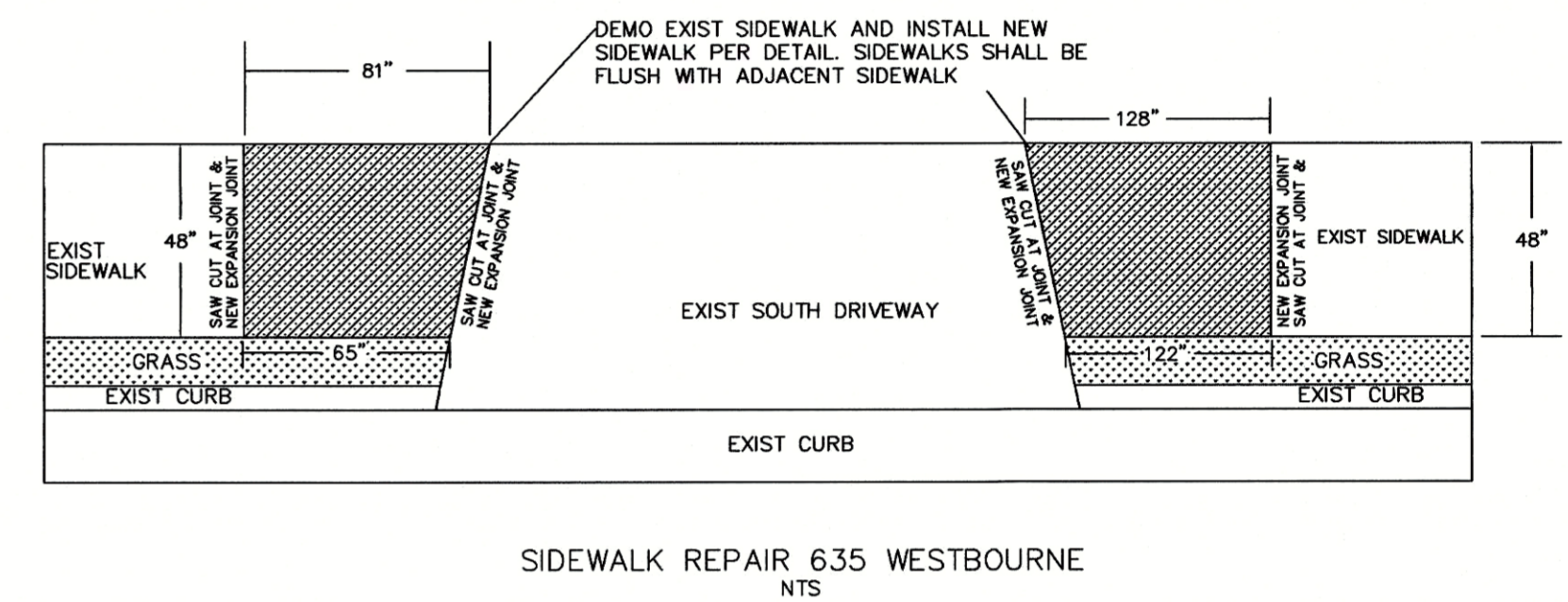
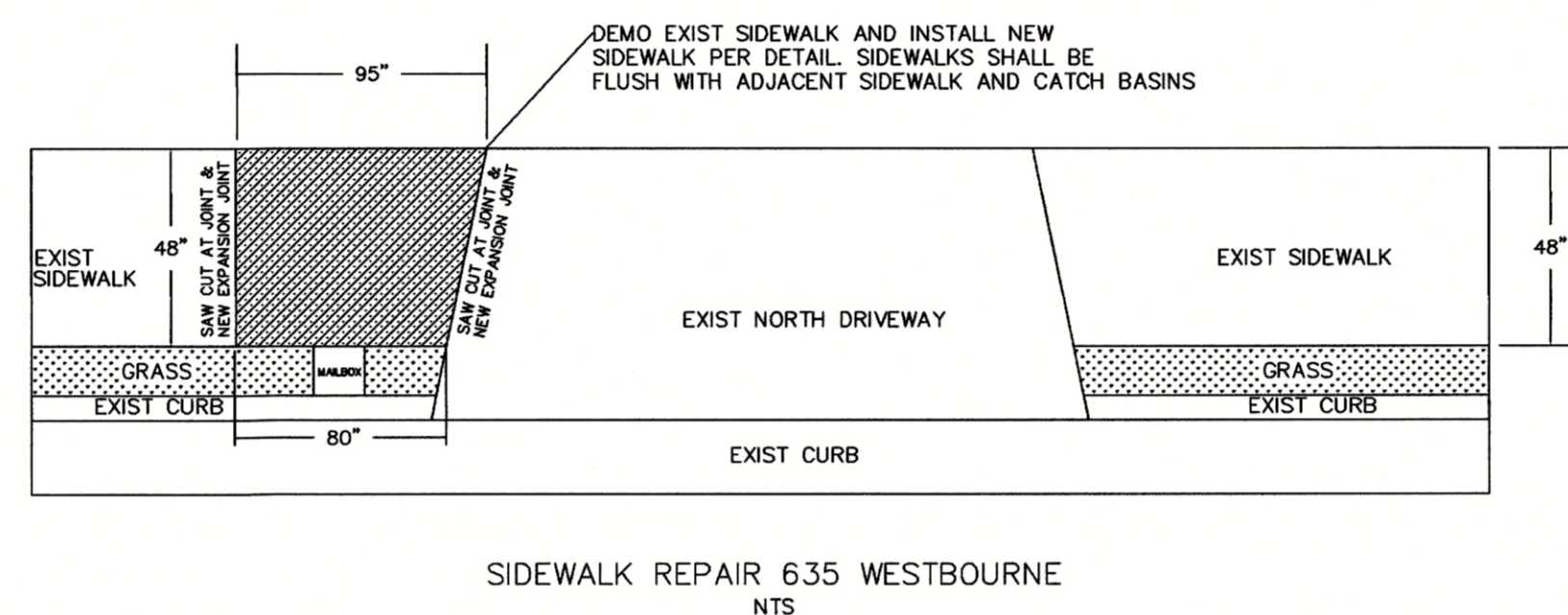
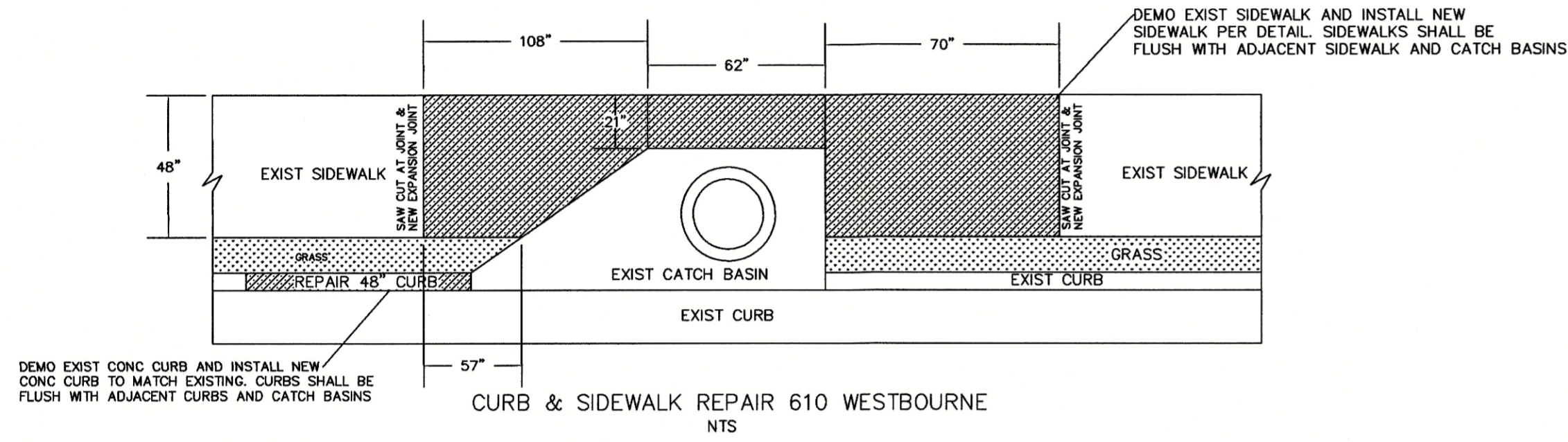
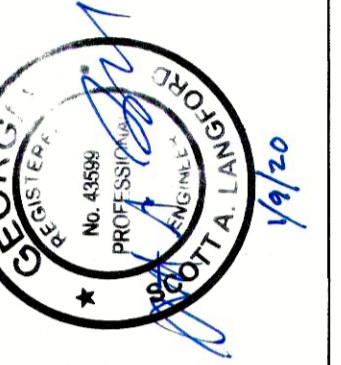

Project Name 2020 SIDEWALK REPAIRS  
 RIVER OAKS AND FARR ROAD

Project No. TPI-0100-2020

Location TOWN OF TYRONE

RIVER OAKS  
 SIDEWALK REPAIRS

Site RIVER OAKS  
 SIDEWALK  
 PLAN VIEW

Sheet Title  
 Scale AS NOTED  
 Designed by SAL  
 Drawn by SAL  
 Sheet No. C102  
 Date JAN 2, 2020  
 Filename: 2020 SIDEWALK REPAIRS

No.	Date	By
1		
2		
3		
4		
5		
6		
7		
8		
9		
10		